

DESIGN YOUR OWN TENDER RIB IN 8 STEPS

DESIGN YOUR OWN TENDER RIB IN 8 STEPS

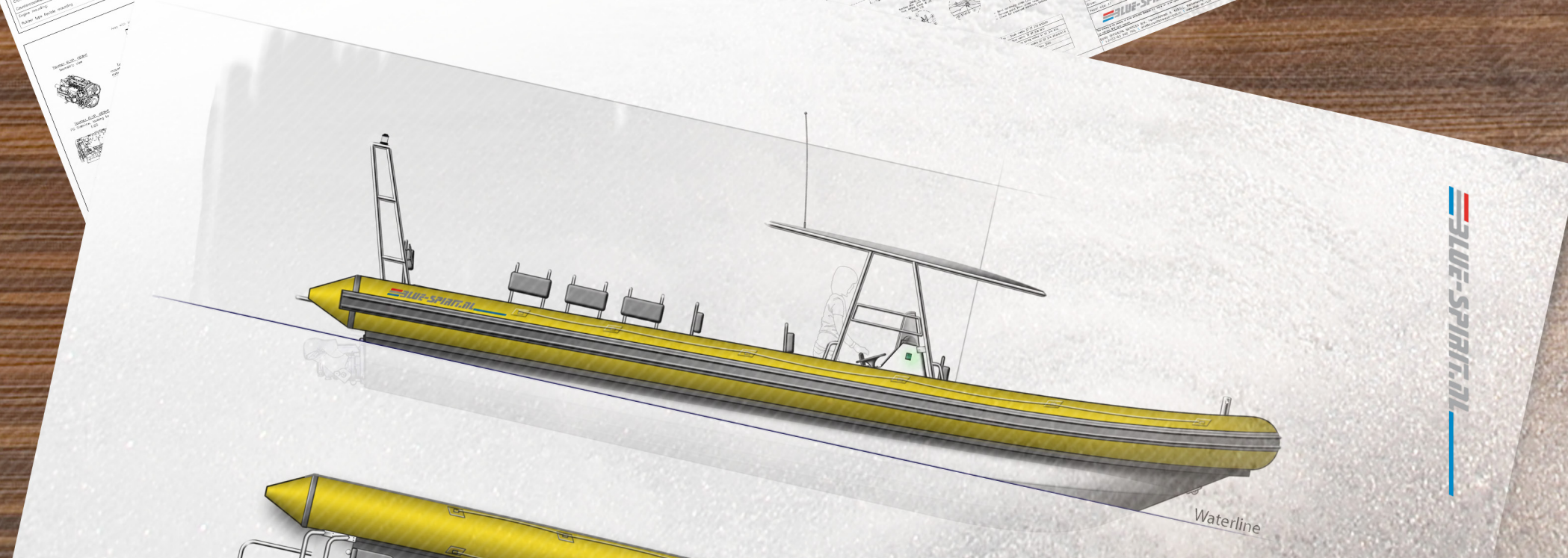

BLUE-SPIRIT.NL





**Main office & Factory Euro Offshore B.V.**

Ferrandstraat 4  
4251 LL Werkendam

Tel: + 31 183 691 010  
Fax: + 31 183 691 019

Email: [info@eurooffshore.nl](mailto:info@eurooffshore.nl)  
Website: [www.eurooffshore.com](http://www.eurooffshore.com)



# About us

Euro offshore B.V. is a custom boat builder in the Netherlands. We design your custom yacht tender together with you. We have more than 25 years of experience and our in-house design team is ready to develop a custom tender that suits your needs.

In the past we have built custom yacht tenders and fast rescue boats for various renowned megayachts. We provide custom solutions in aluminum and GRP to fit your tender garage.

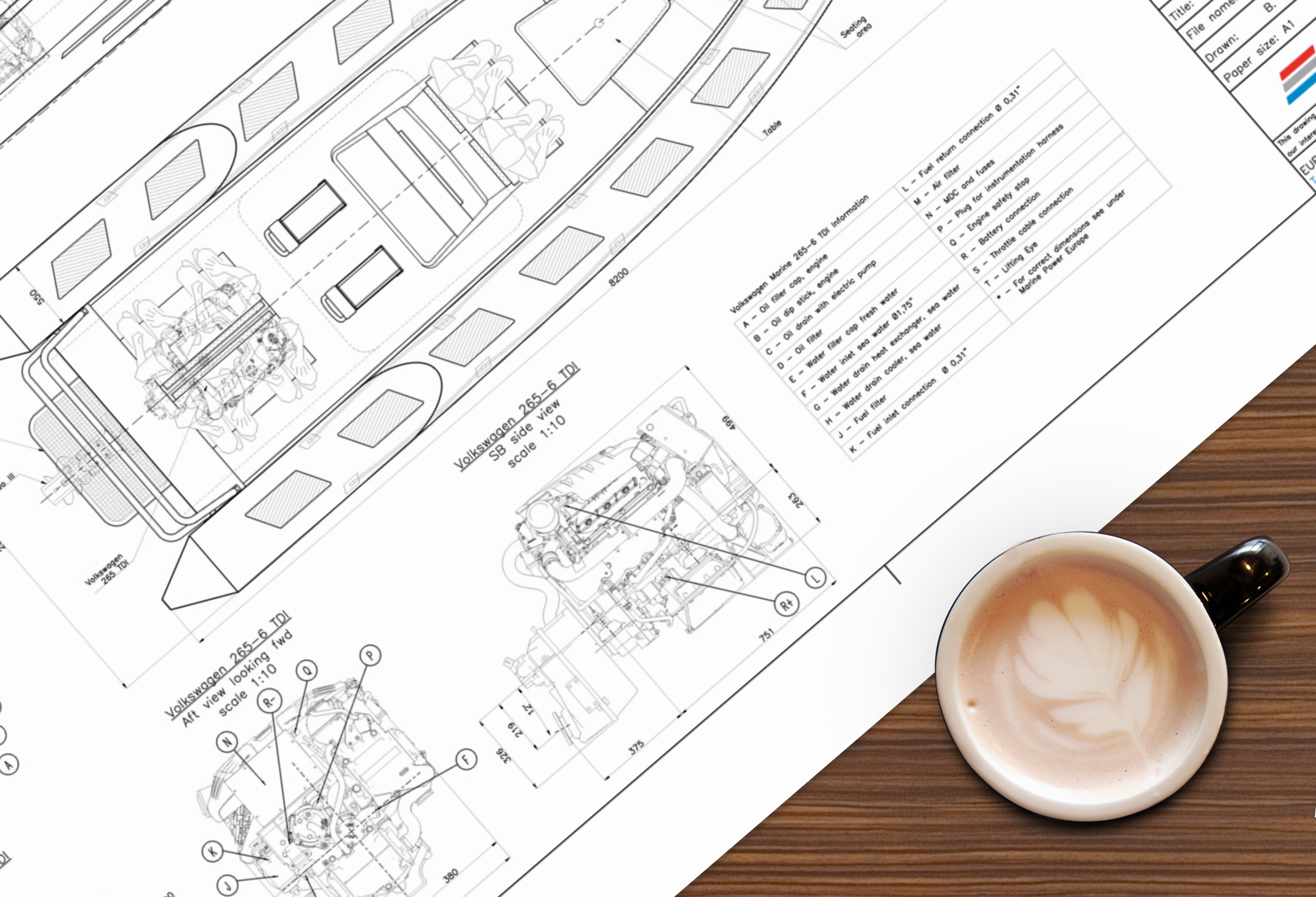

Title: B.  
File name: B.  
Drawn: B.  
Paper size: A1  
EURO OFFSHORE SERVICES B.V. Ferrandstr.  
T +31(0)183 500 765, E info@eurooffshore.nl

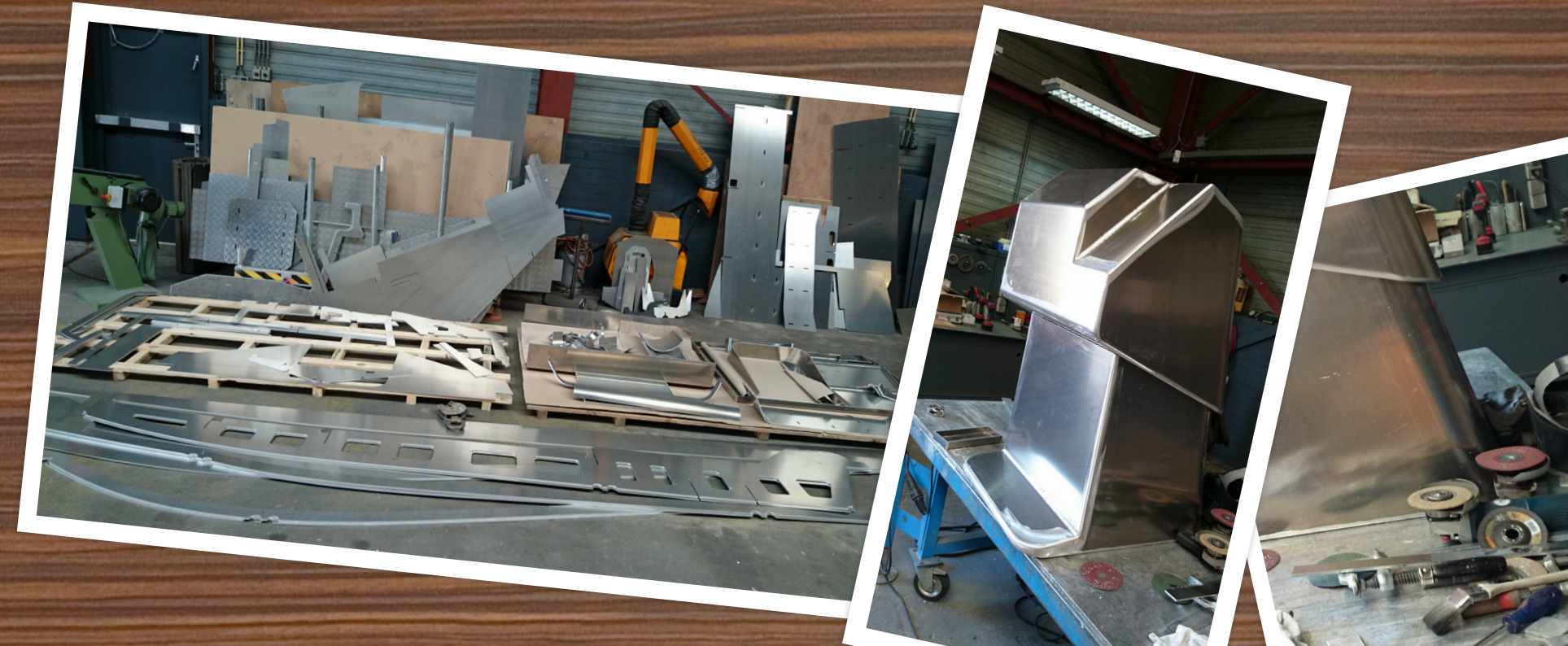



# Your Design

Design your own Tender Rib  
in 8 steps!

Step 1. Specifications LxBxH?

Step 2. Aluminium / GRP?

Step 3. Engine configuration?

Step 4. Concept sketch

Step 5. Detailed CAD drawing

Step 6. Colour configuration

Step 7. Production

Step 8. Testing

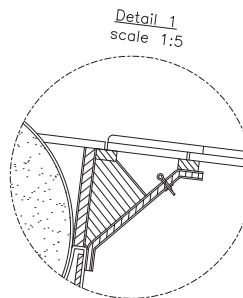
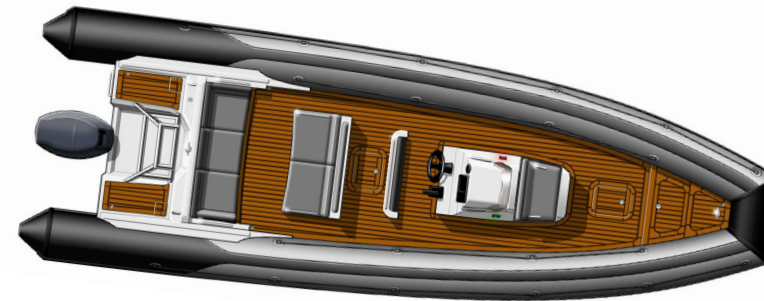
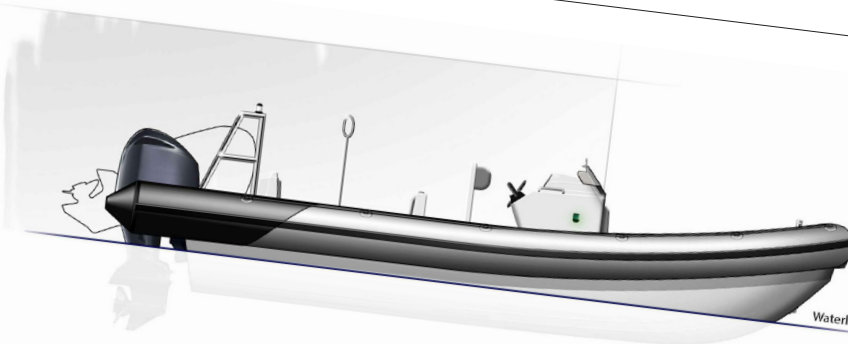

#### BS 26 YT specifications

LOA:	8200 mm, 8500mm with engine up
Beam (max):	2736 mm
Weight:	... kg
Engine:	Yamaha 300 hp
Hull:	Vacuum injection
Tube:	Hypalon Neoprene 1670 DTEX coated
Rollbar:	Stainless steel

Project name:	BS 26 YT MY Skat		
Title:	Presentation Blue Spirit 26 YT		
File name:	BS 26 YT.dwg		
Drawn:	B. van der Wijk		
Paper size:	A1	Scale:	1:20 / 1:10
Date:	05-07-2012	Sheet:	1/1



This drawing is the property of EURO OFFSHORE SERVICES B.V. and is not to be reproduced nor used in any matter detrimental to our interests. All rights reserved.  
EURO OFFSHORE SERVICES B.V., Ferrandstraat 4, 4251LL, Werkendam, The Netherlands  
T +31(0)183 500 765, E info@eurooffshoreservices.nl, I www.blue-spirit.nl







# Blue Spirit Sport 5m20 Custom

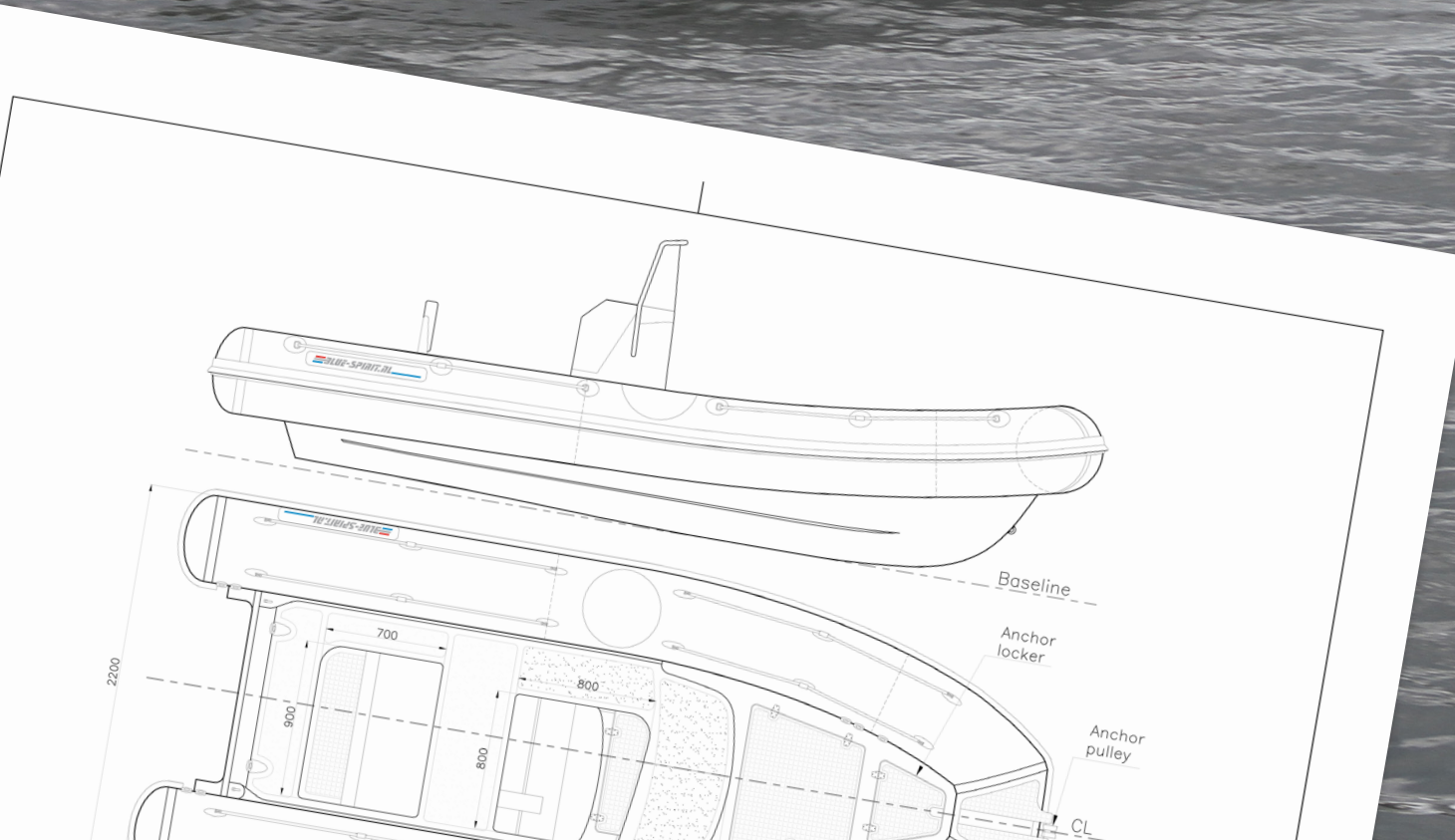
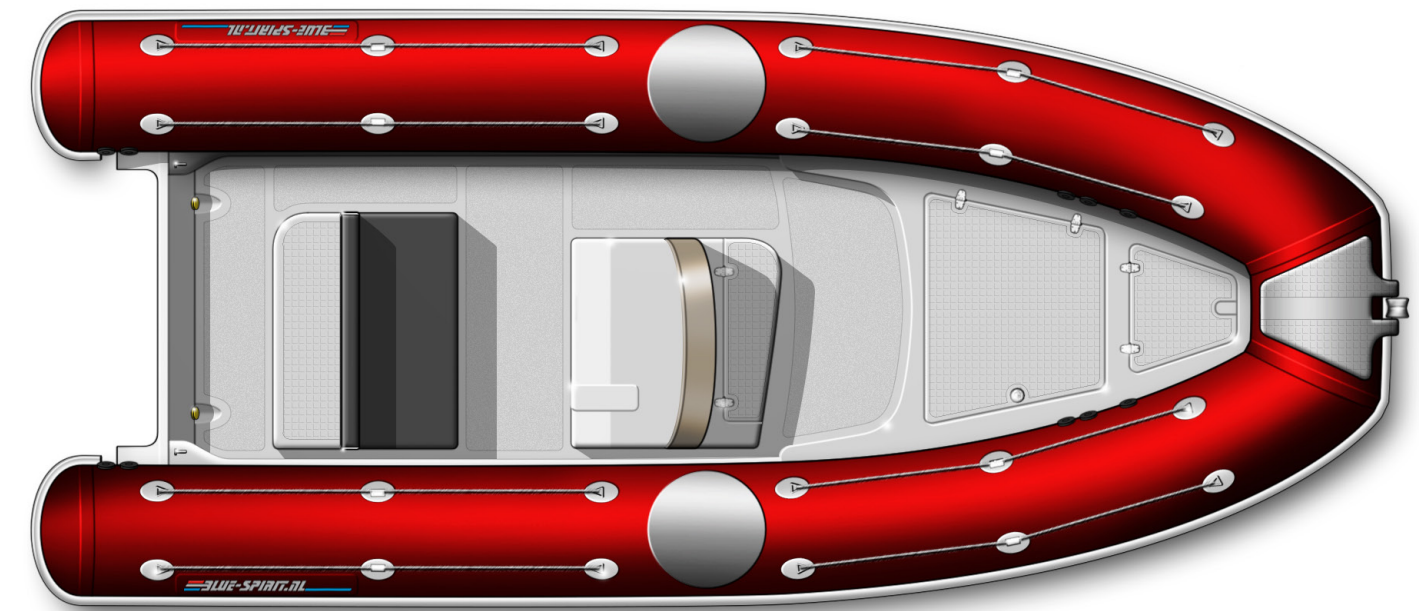
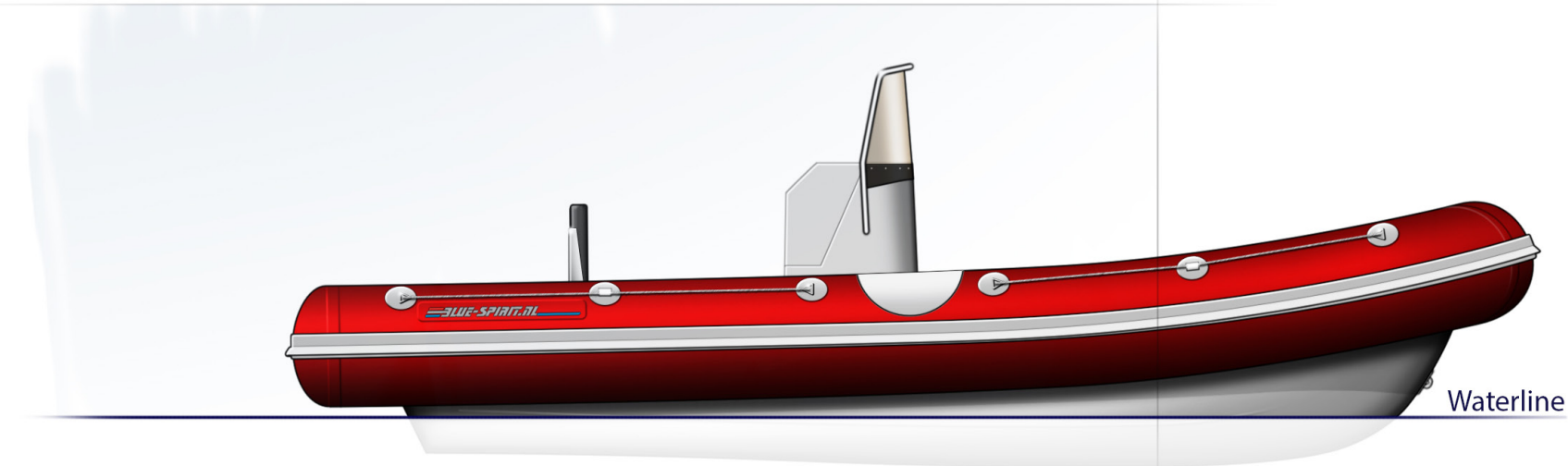



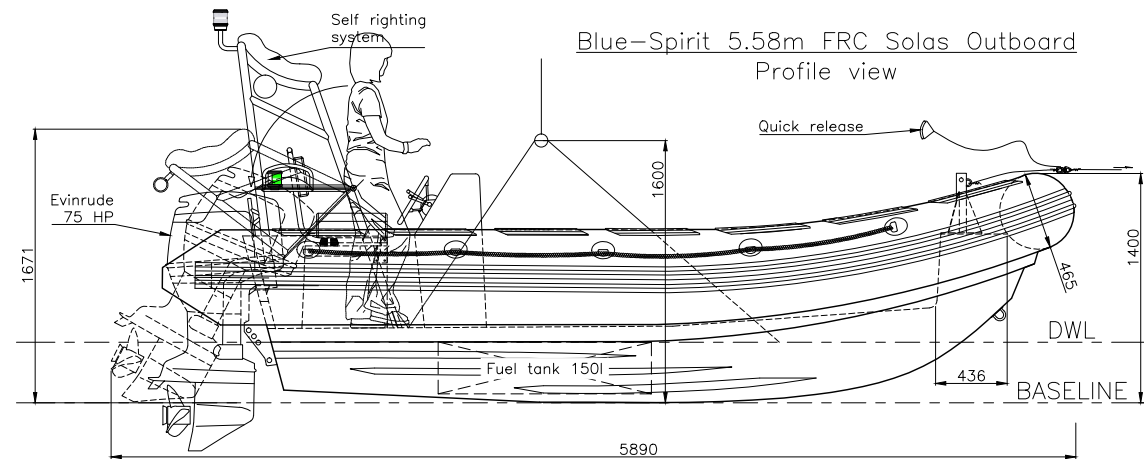

Blue-Spirit 5.58m FRC Solas Outboard  
Profile view

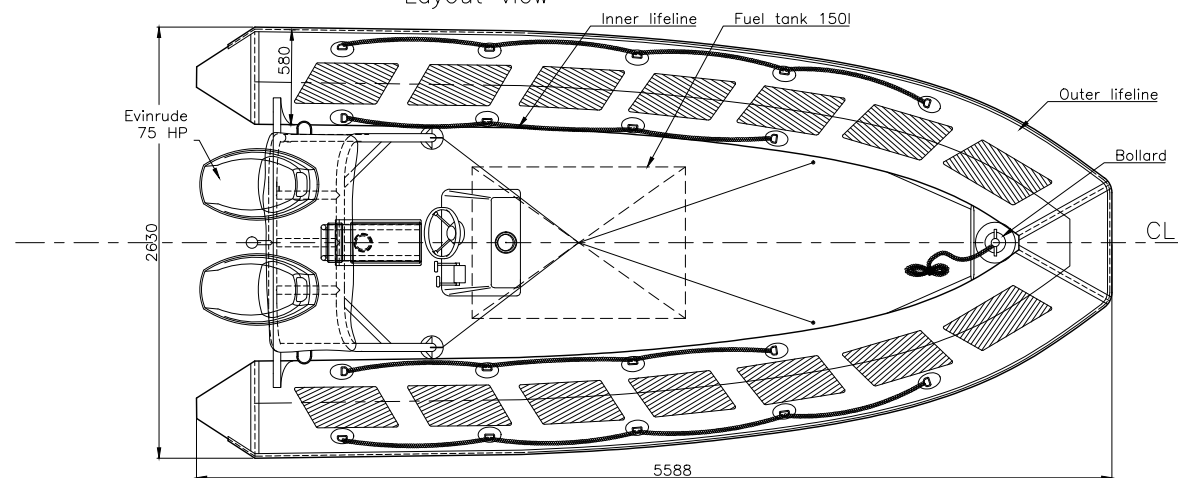

Blue-Spirit 5.58m FRC Solas Outboard  
Layout view

Blue Spirit 5m58 FRC Solas

LOA:	5588 mm (engine up)
Beam (max):	2630 mm
Weight:	1147 kg with full fuel tank, ex persons
Total weight:	1807,0 kg (with persons)
Person capacity:	8 persons
Engine:	Evinrude 75 HP
Hull:	GRP
Fuel tank:	150 Liter
Approval:	Solas/MED
Tube:	Hypalon air filled / Hypalon foam filled



This drawing is the property of EURO OFFSHORE B.V. and is not to be reproduced nor used in any matter detrimental to our interests. © All rights reserved.

EURO OFFSHORE B.V., Ferrandstraat 4, 4251LL, Werkendam, The Netherlands  
T +31(0)183 691 010, E info@eurooffshore.nl, I www.blue-spirit.nl

File name:	Blue Spirit 5m58 FRC Solas.dwg	Project name:	Blue Spirit 5.58m FRC Solas outboard
Paper size:	A3	Title:	Profile view & layout
Scale:	1:30	Drawn:	B. van der Wijk
Sheet:	1/2	Date:	14-10-2013

Blue Spirit 5m58 Custom FRC





# Blue Spirit 5m70 Custom

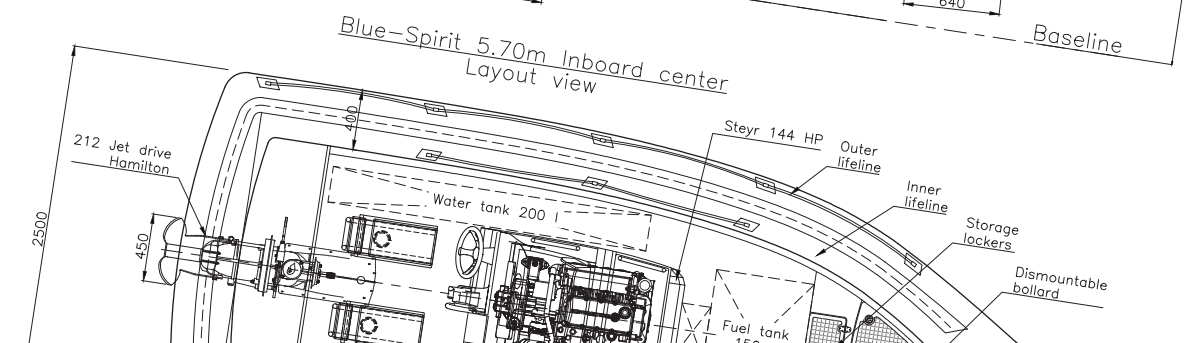
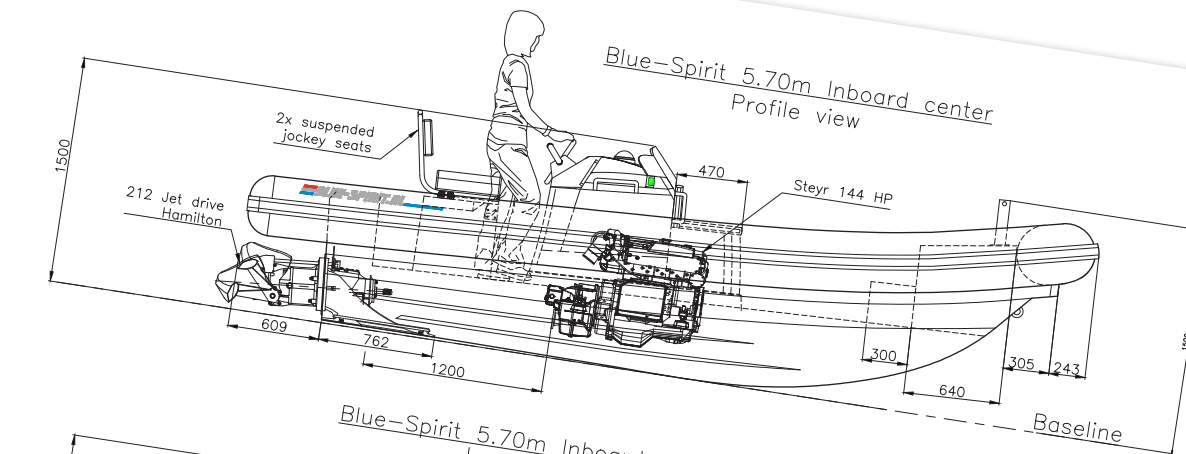
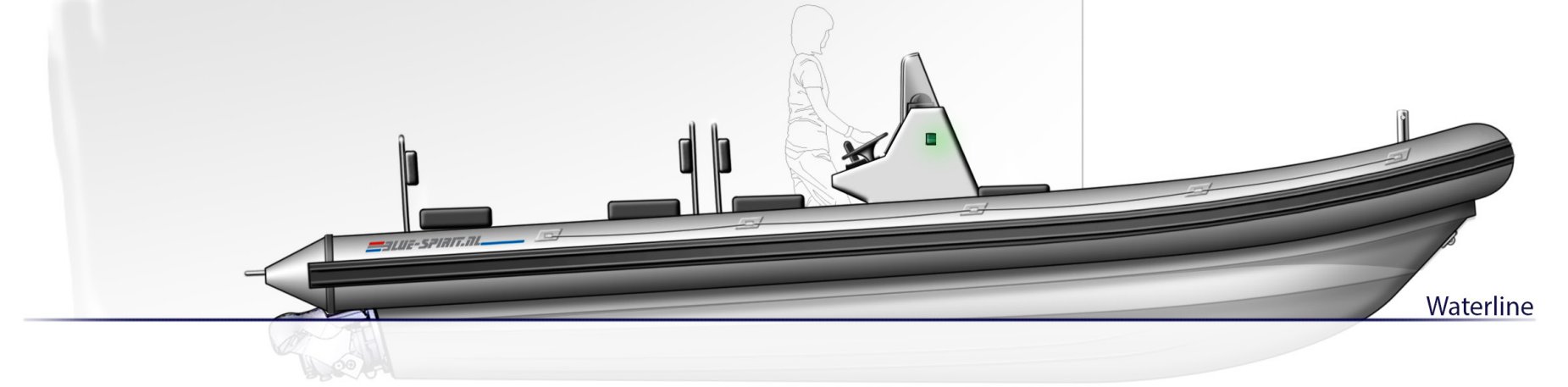
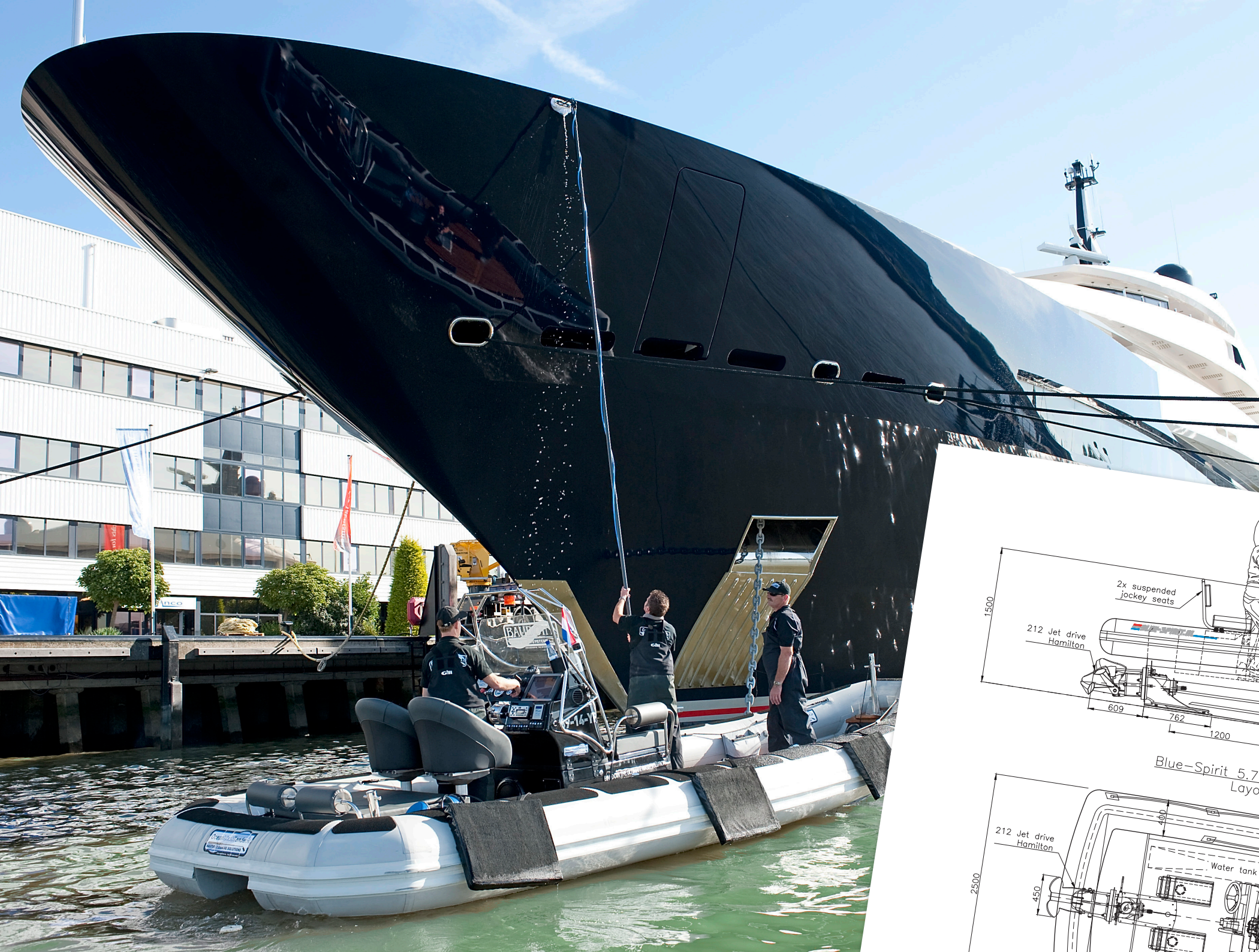



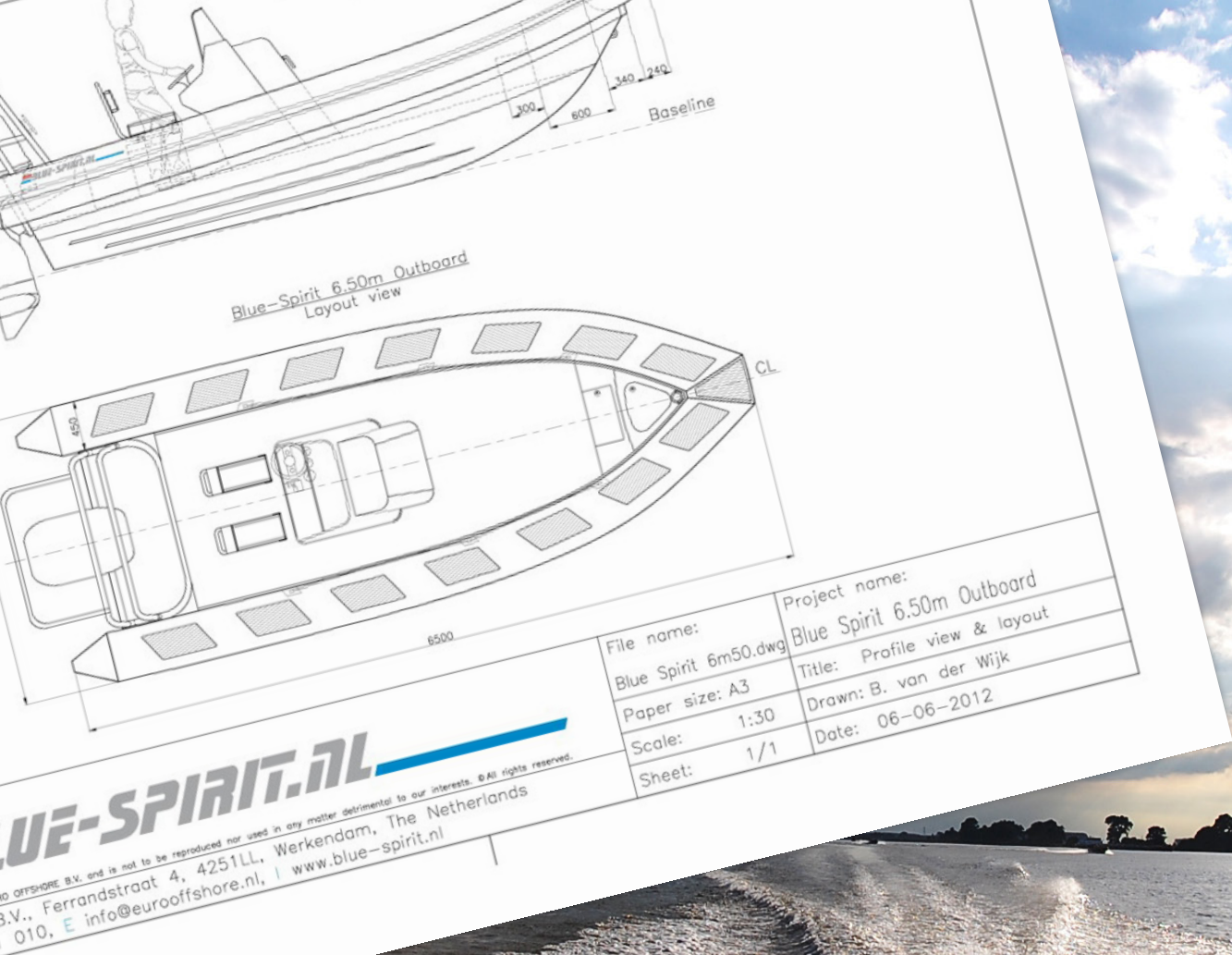

# Blue Spirit 6m50 Custom

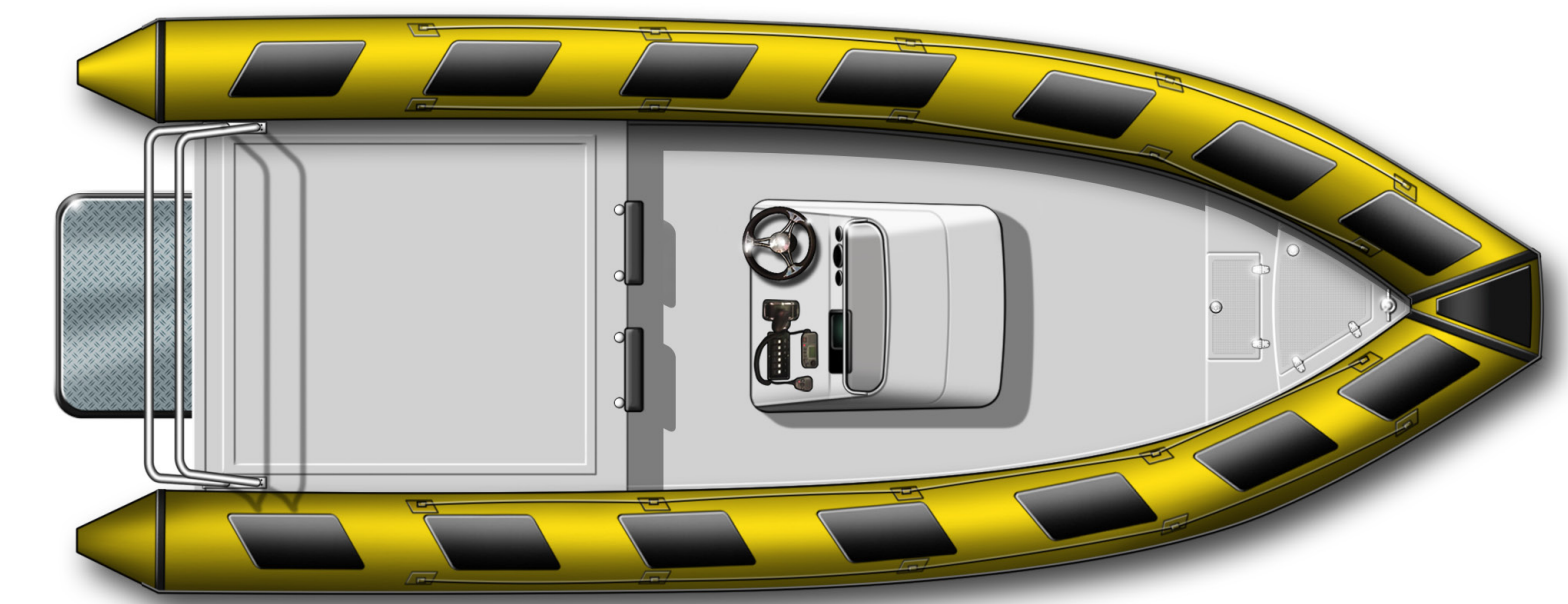
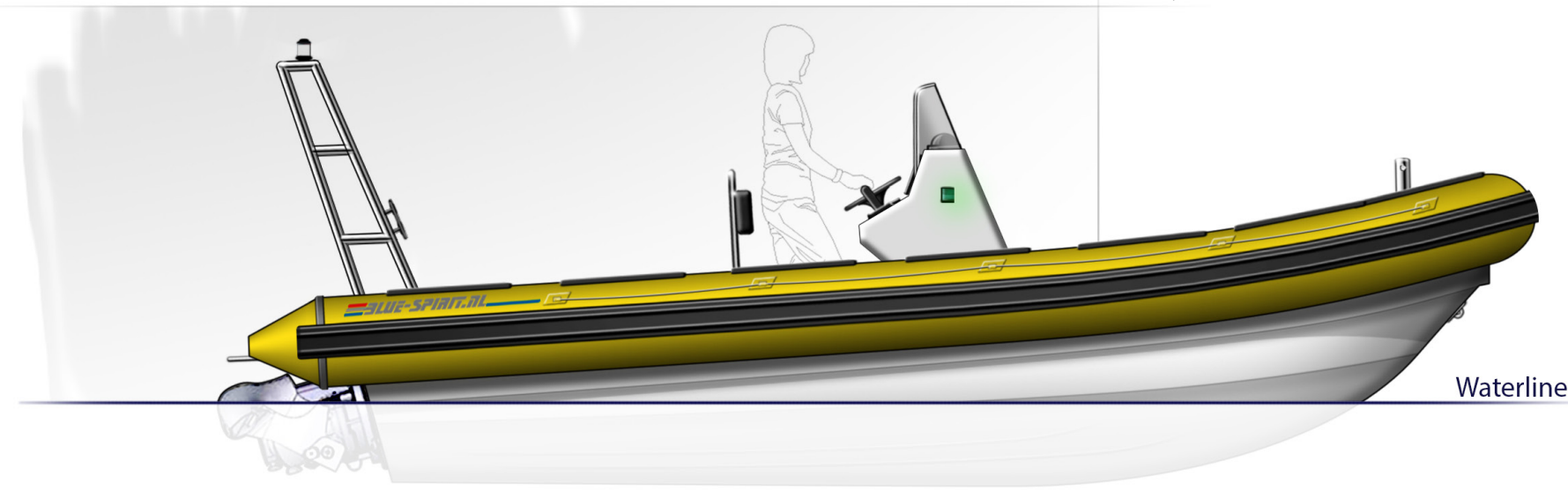



Yanmar 8LV-350  
View, looking down

Yanmar 8LV-350  
View, looking to PS

Yanmar 8LV-350  
Aftview, looking fwd

Yanmar 8LV-350  
PS sideview, looking to SB

Yanmar 8LV-350 Information

Max Output:	350 mhp @3800rpm
Displacement:	4.46 ltr
Bore x stroke:	86mm x 96mm
Cylinders:	D - Oil filter
Combustion sys:	Direct injection common rail
Compression:	ratio 15:8
Low idle rpm:	560 rpm
Aspiration:	Turbocharged with twin TC
Electrical sys:	12 V
Alternator:	12V - 180A
Dry weight:	435kg without gear
Lubrication system:	Enclosed, forced lubrication system
Crankshaft rotation:	Counterclockwise viewed from flywheel side
Engine mounting:	Rubber type flexible mounting

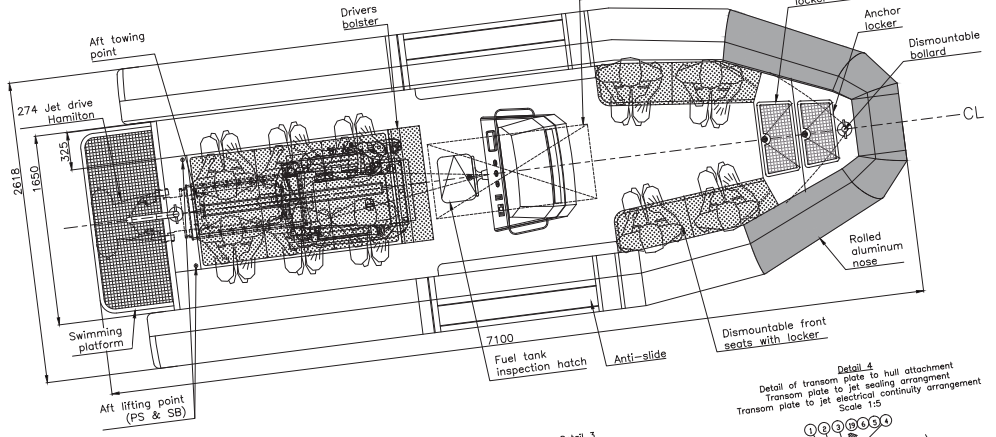
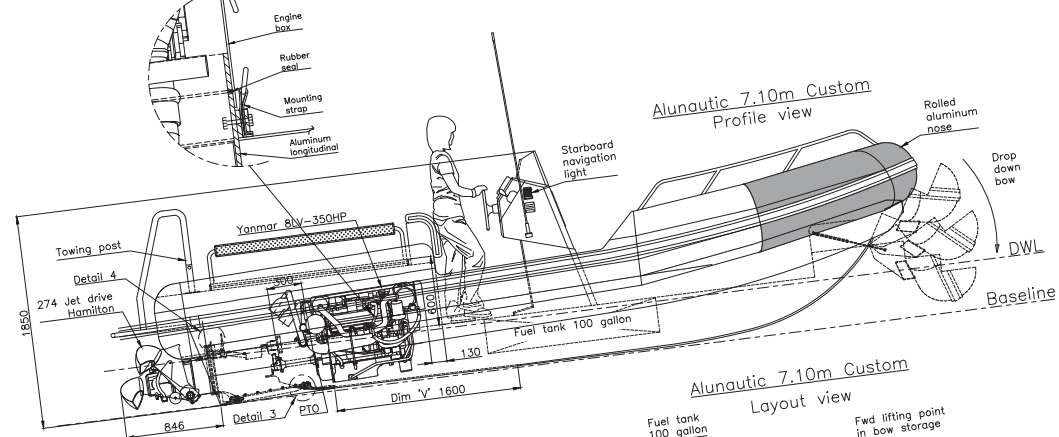

Hamilton 274 Jet drive information

1 - Transom plate	14 - Studs metric ST ST 316 M12x54
2 - O-ring transom plate	15 - Nuts metric ST ST 316 M12
3 - Screw metric ST ST 316 HEX HD M8x55	16 - Washers spring metric ST ST 316 M12
4 - Nuts metric ST ST 316 M8	17 - Washers flat metric ST ST 316 M12x24x1.6
5 - Washers spring metric ST ST 316 M8	18 - Neut-cure RTV Silicone 310G
6 - Washers flat metric ST ST 316 M8x16x1.2	19 - Loctite 262 10ML Bottle
13 - Screen (0 degree shaft line)	20 - Jet packaging bolt box

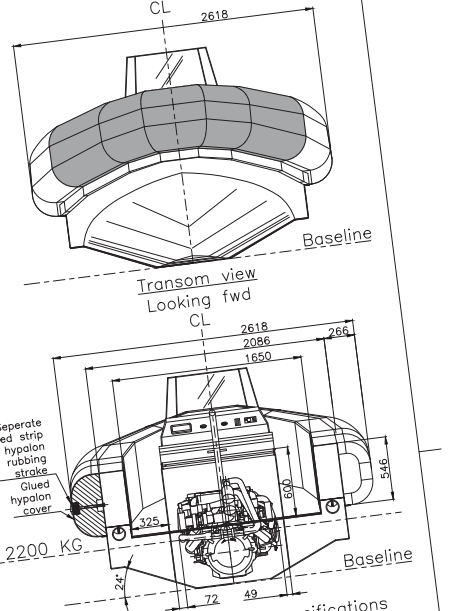

Rev	Date	Description
Project name: Alunautic 7m10 Custom		
Title: Alunautic 7m10 Custom presentation		
File name:	Alunautic 7m10 Custom.dwg	Date: 03-06-2013
Drawn:	B. van der Wijk	Scale: 1:20
Sheet:	2-3	

alunautic.nl

The drawings are the property of EURO OFFSHORE SERVICES B.V. and is not to be reproduced nor used in any matter without the prior written consent of EURO OFFSHORE SERVICES B.V. All rights reserved.

EURO OFFSHORE SERVICES B.V., Ferrandstraat 4, 4251LL, Werkendam, The Netherlands  
T: +31(0)183 500 765, E: info@eurooffshoreservices.nl, I: www.alunautic.nl

# Alunautic 7m10 Custom





# Blue Spirit 7m50

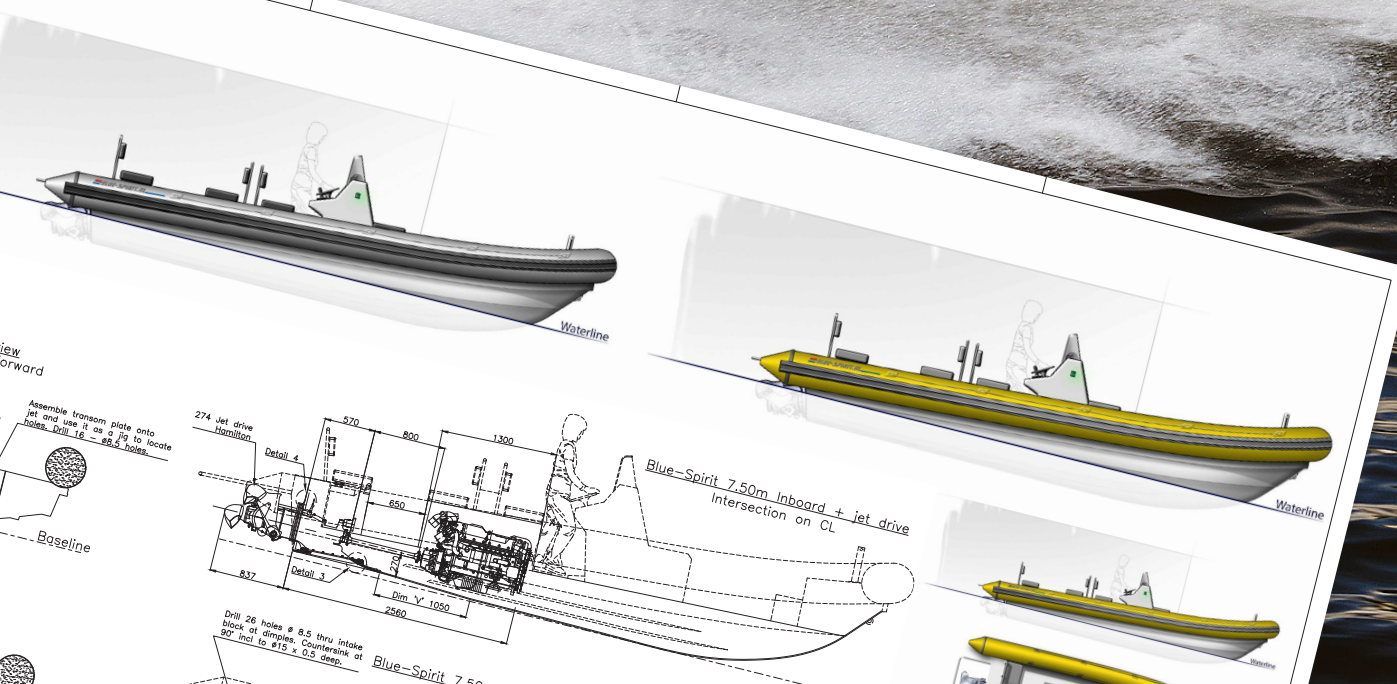
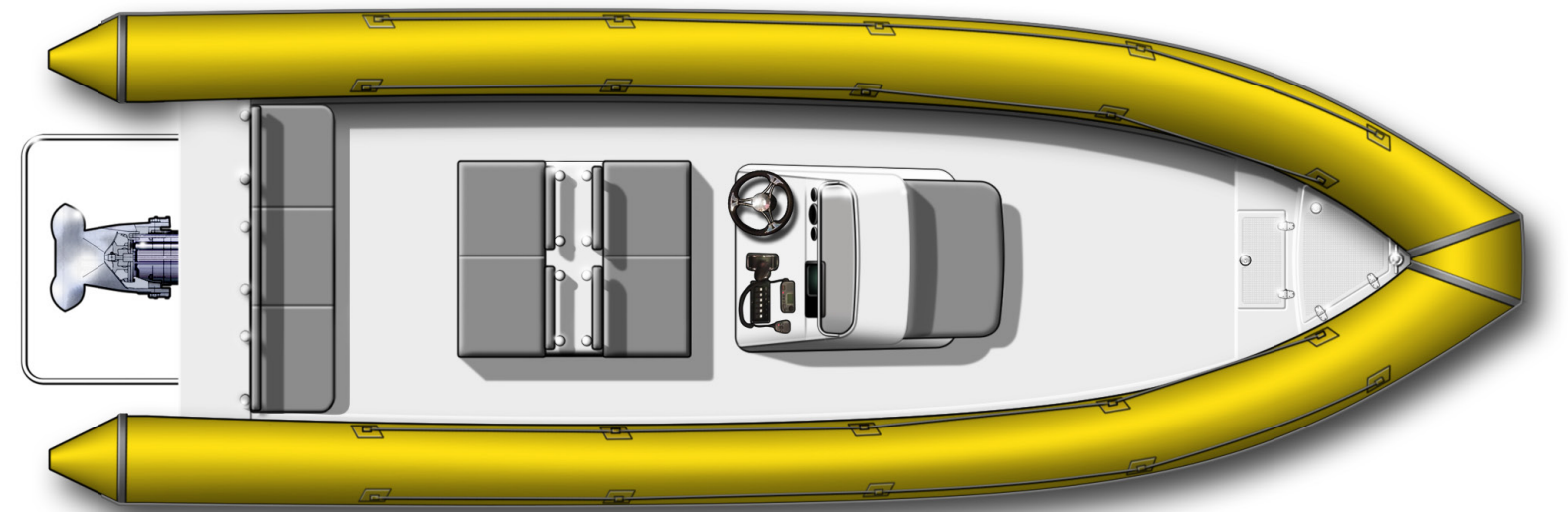
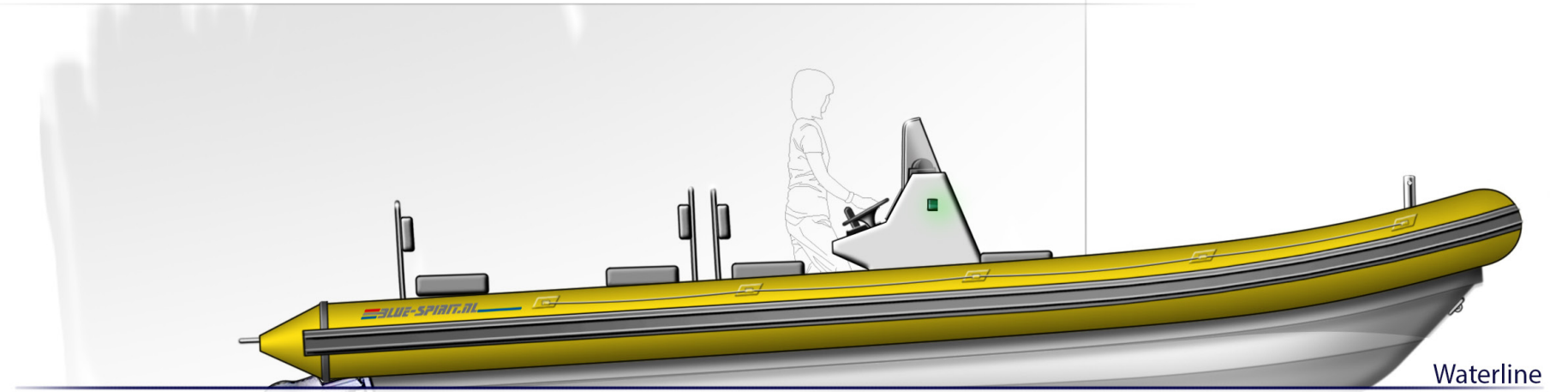



# Blue Spirit 8m20 Patrol

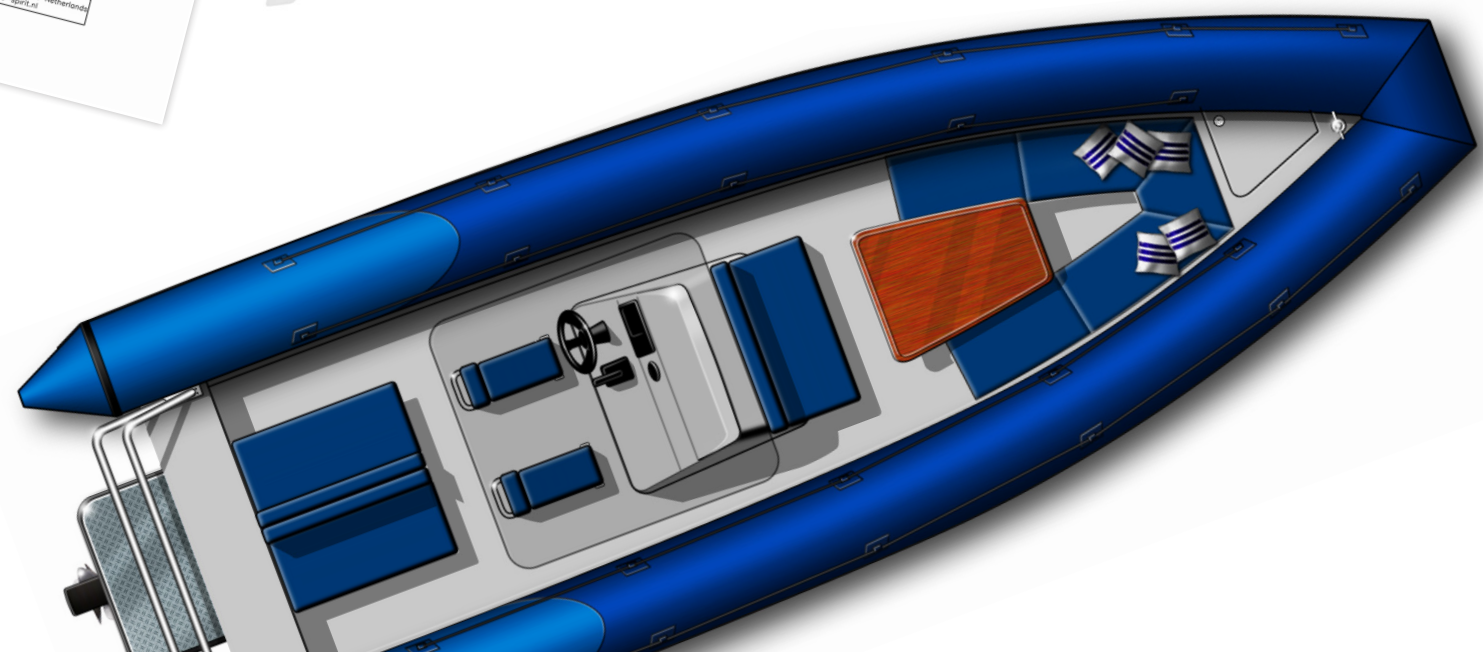
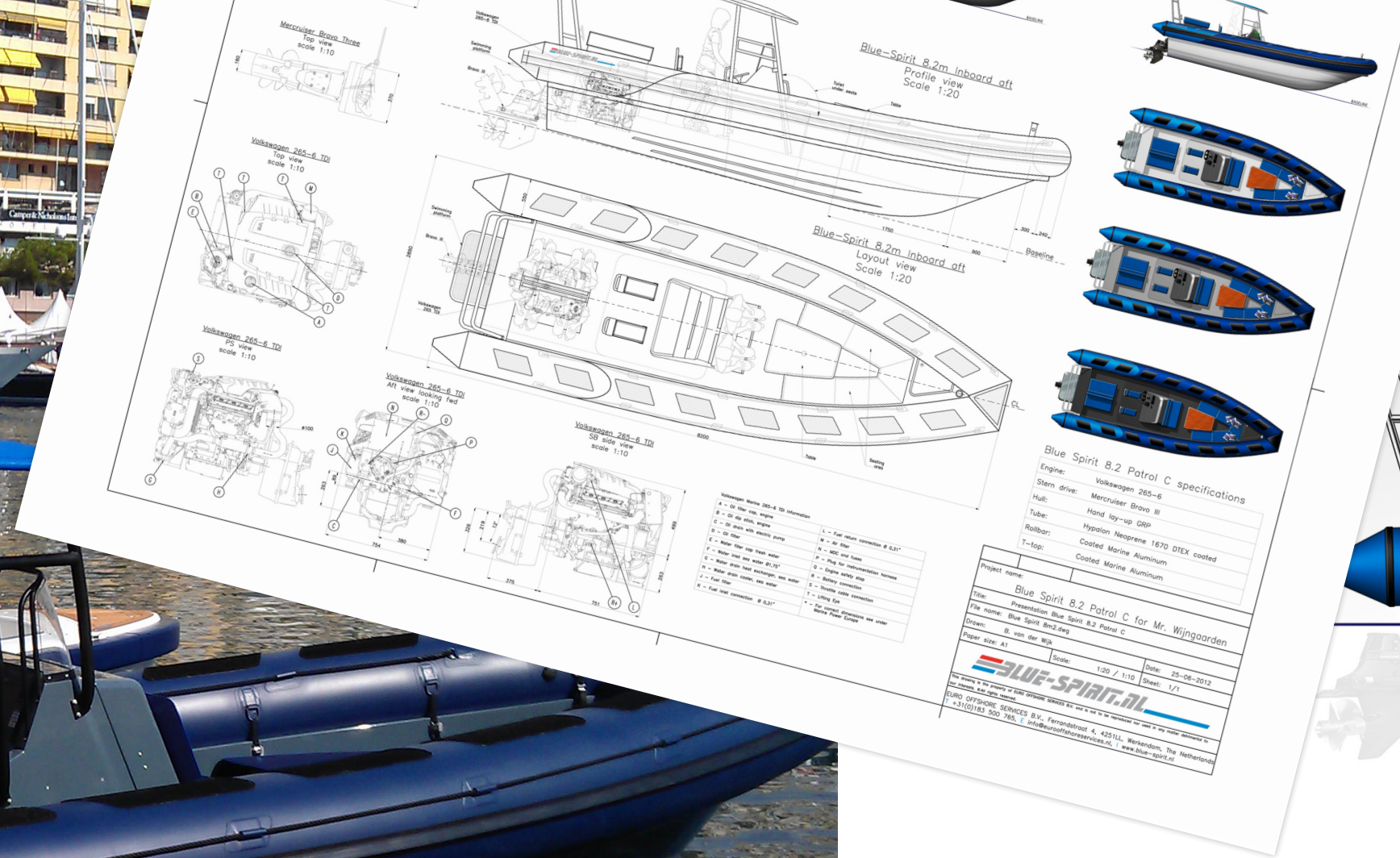



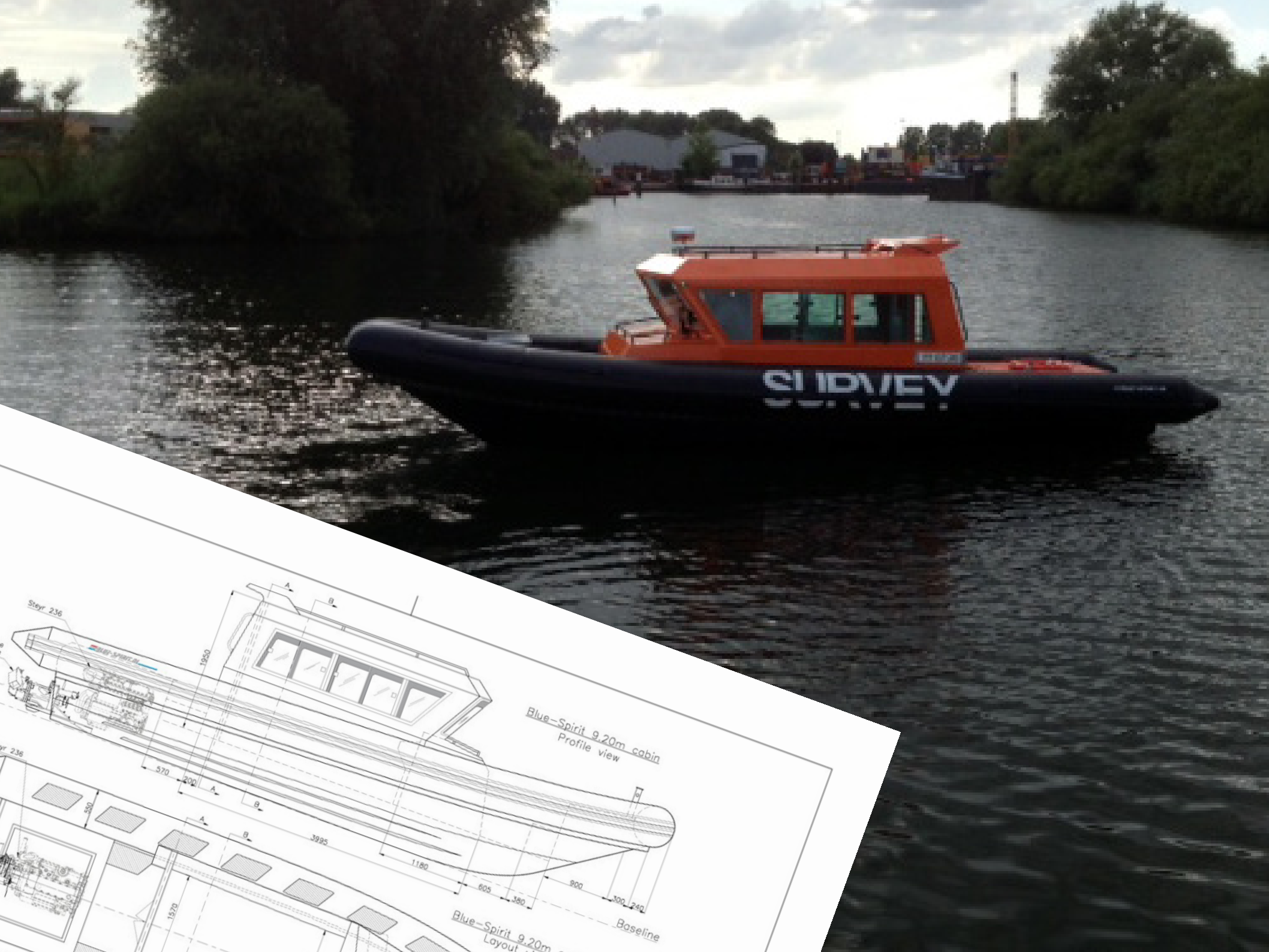

# Blue Spirit 9m20 Cabin

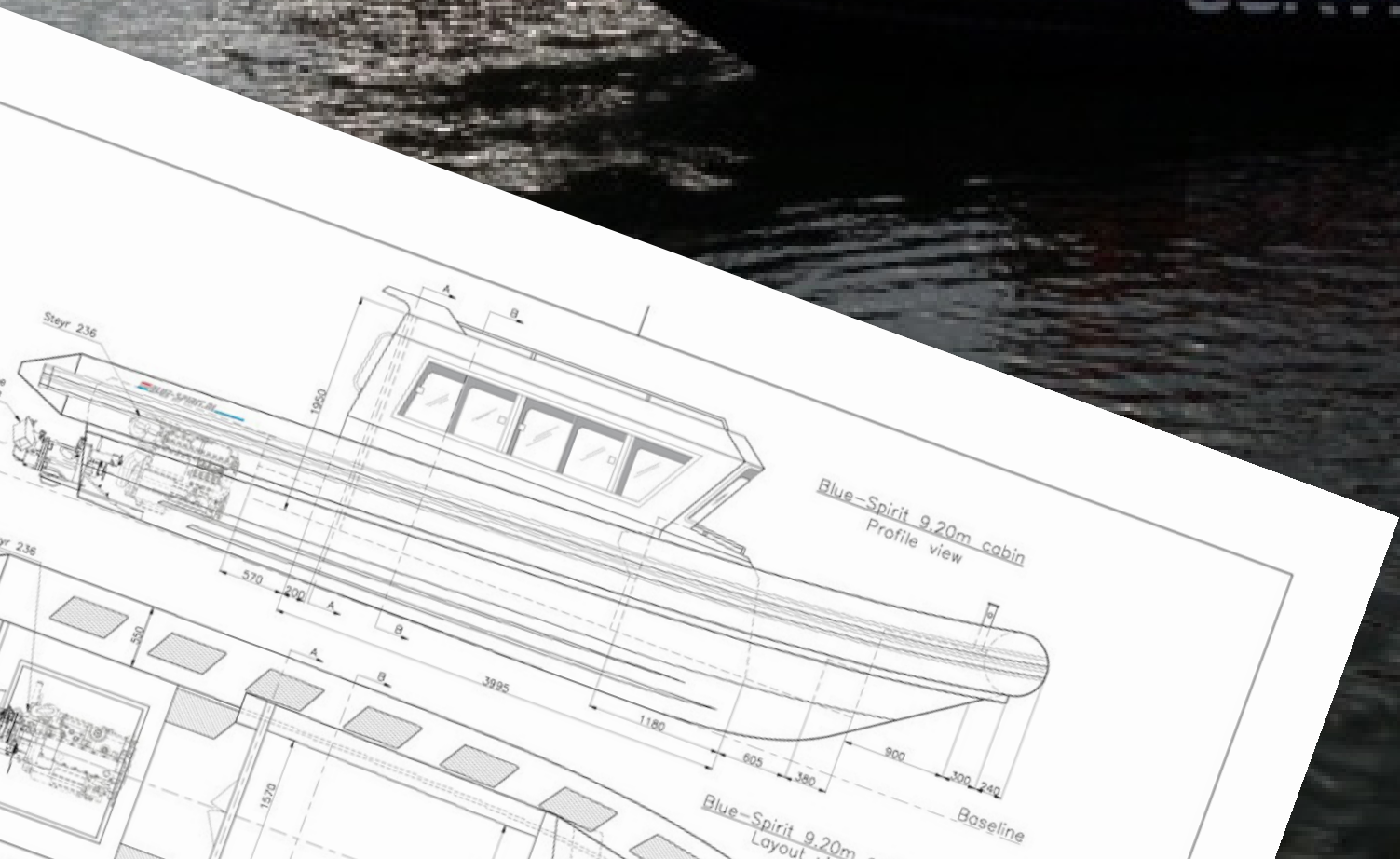
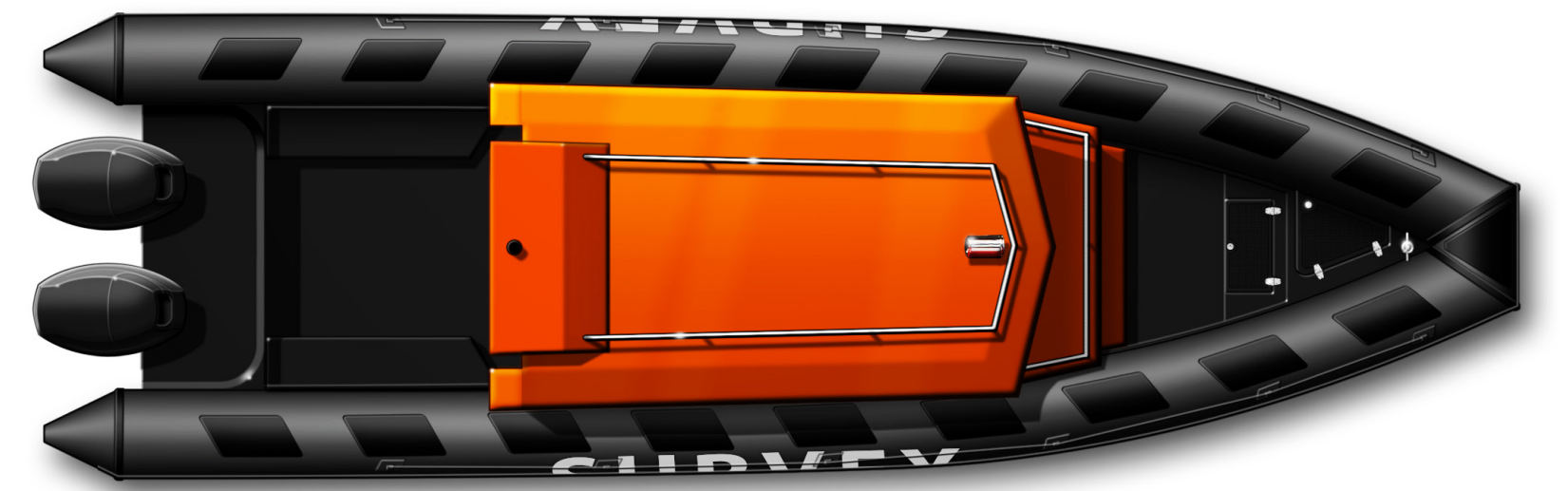



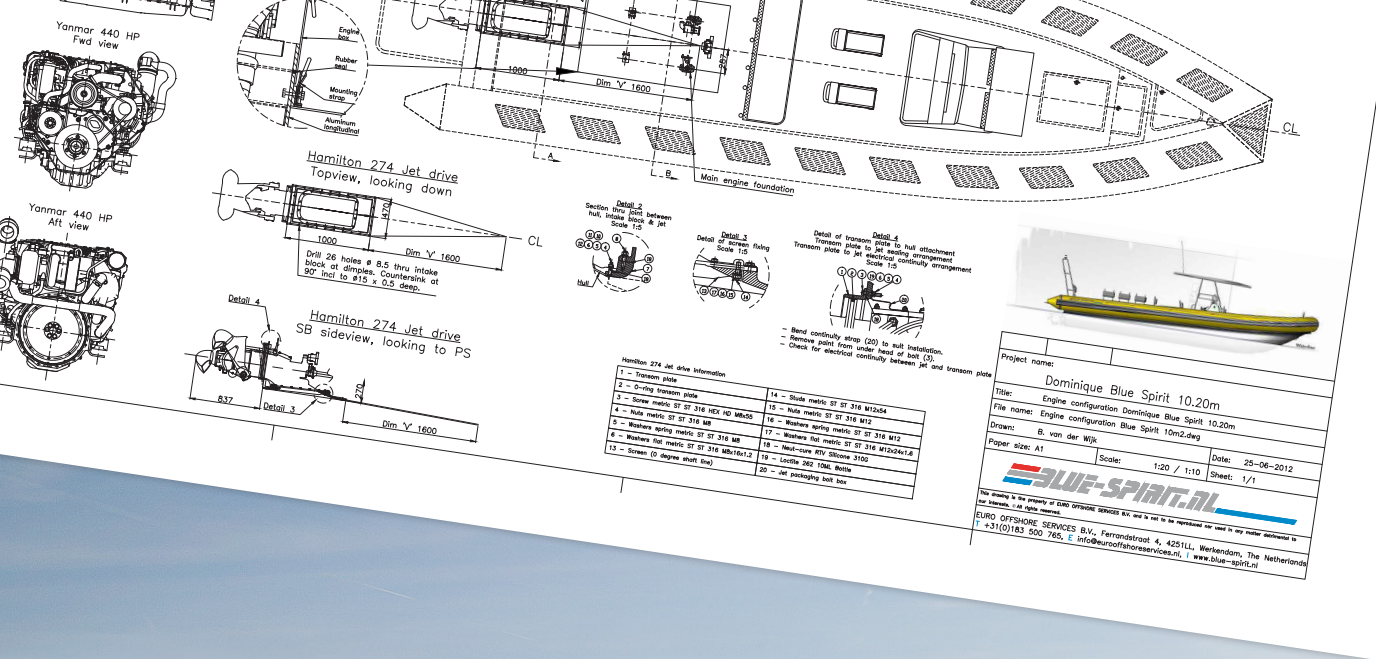

# Blue Spirit 10m20

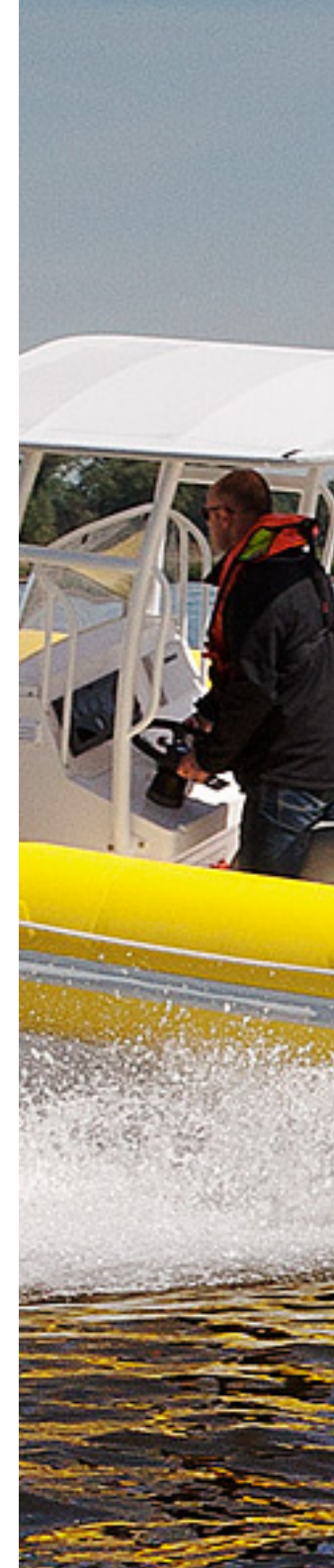
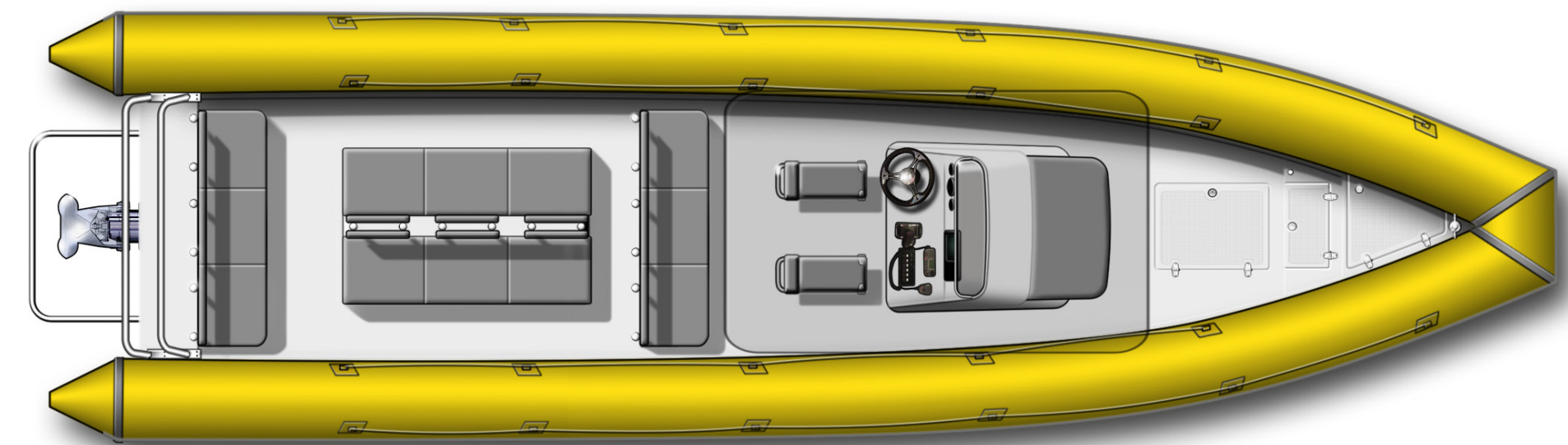
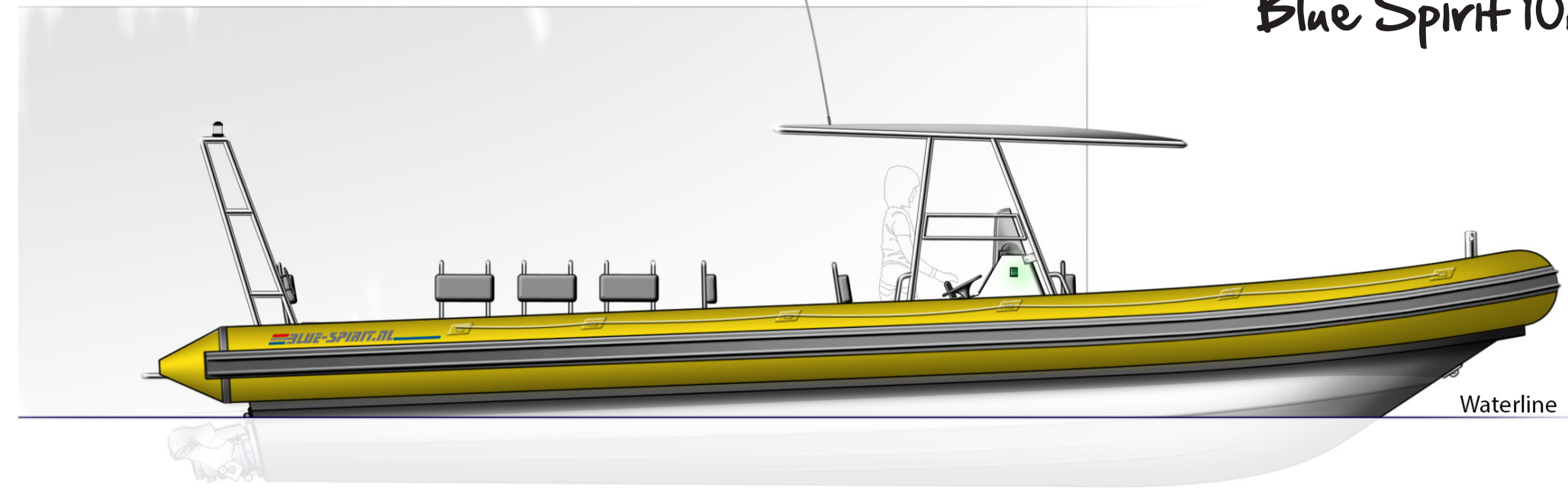





# Blue Spirit 10m20 Patrol Cruiser

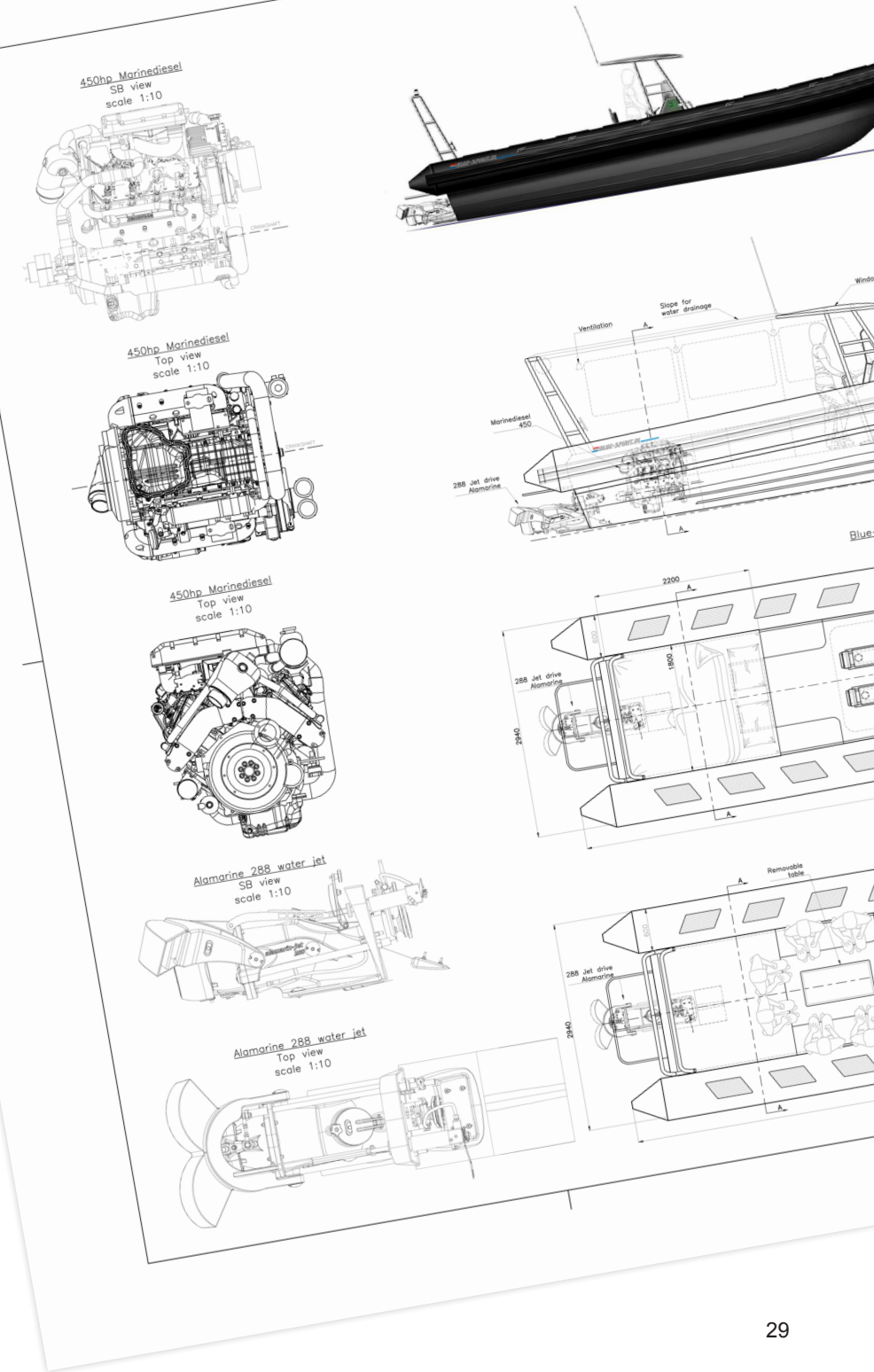
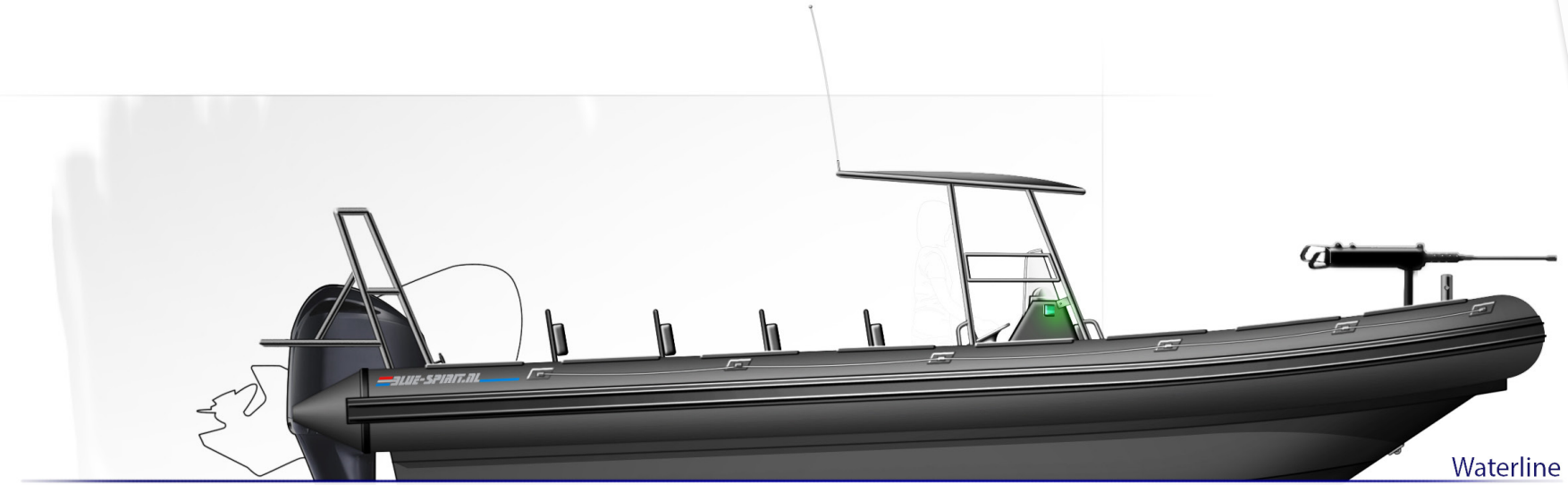





# Blue Spirit 10m20 Dive Rib

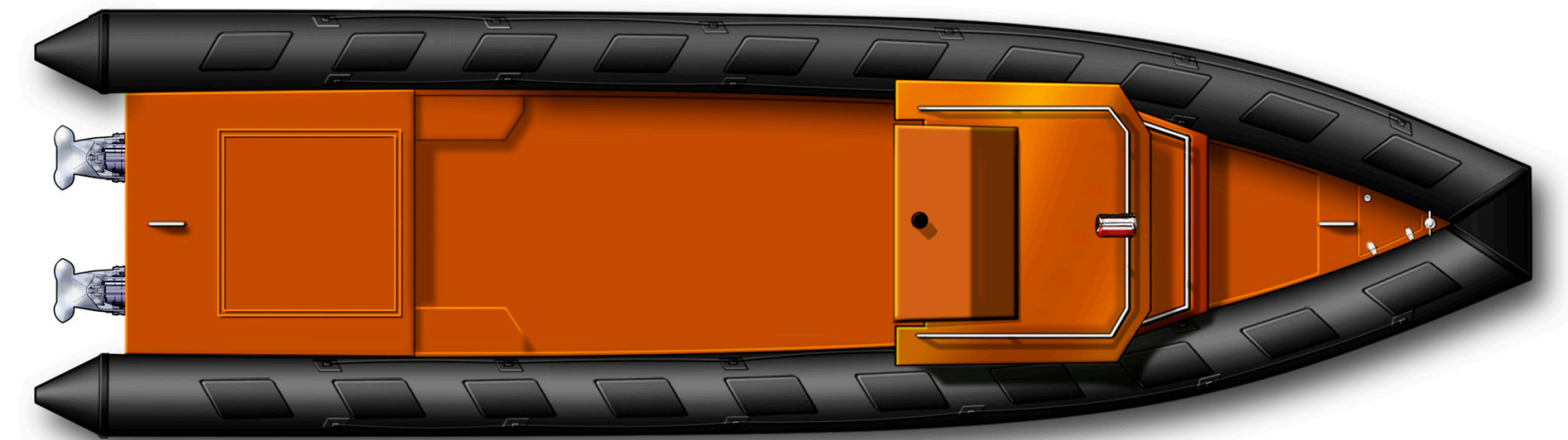



# Alunautic 12m40 Yacht tender

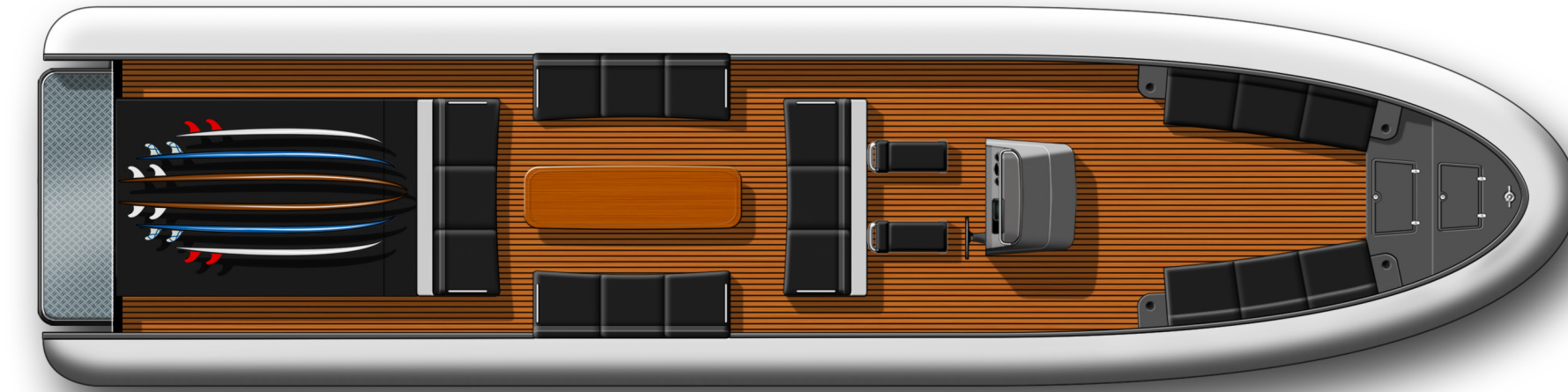
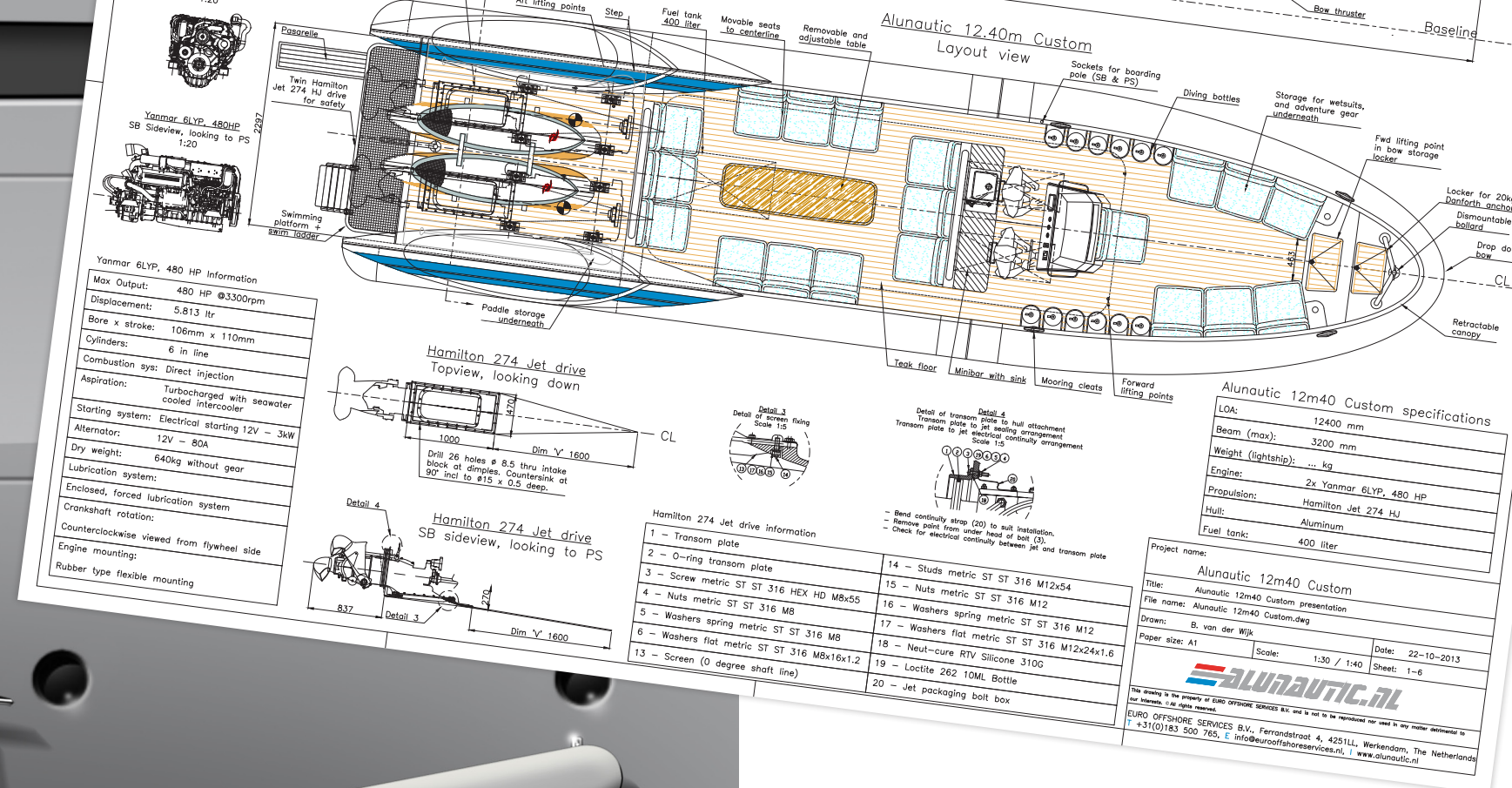
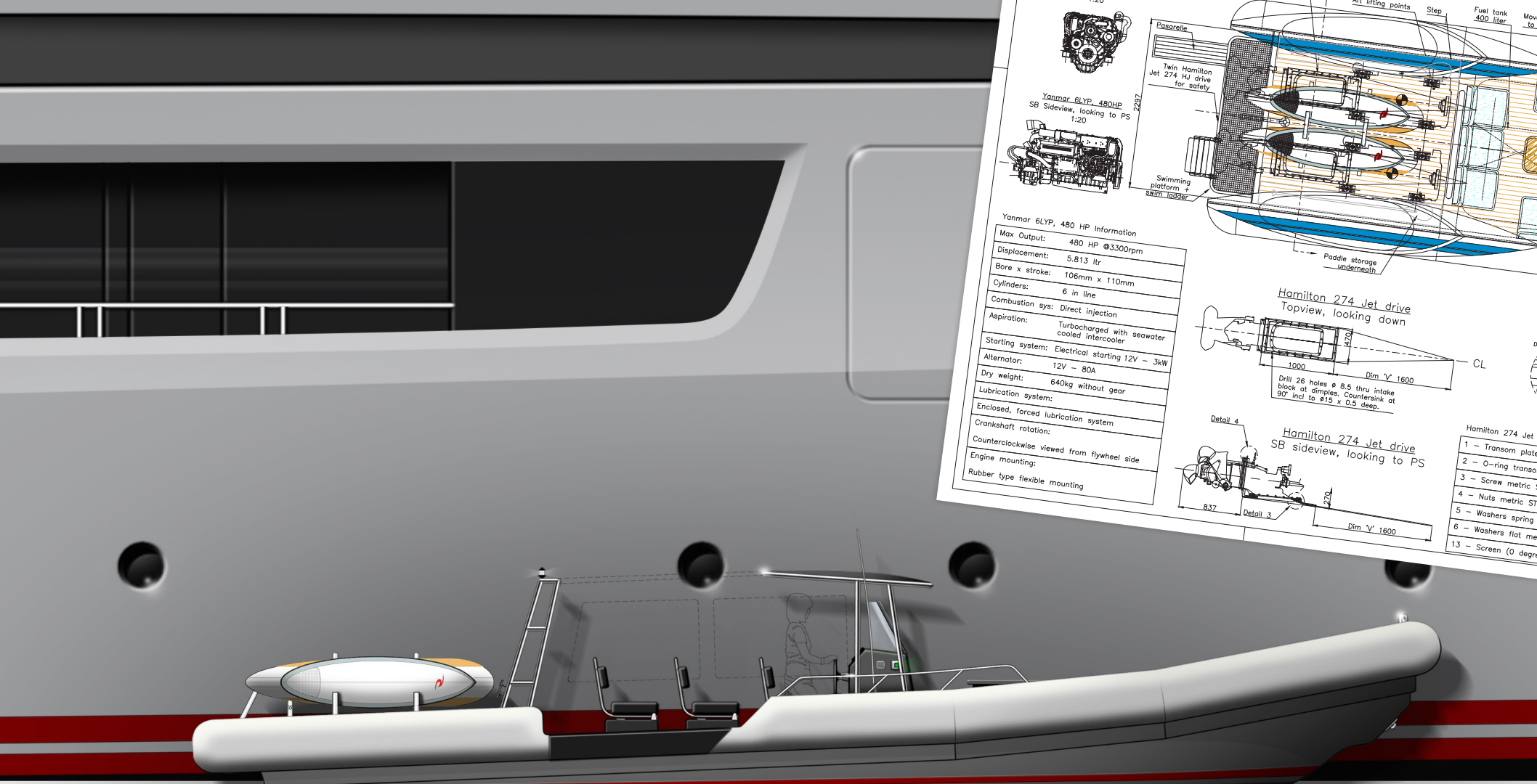

12.40m Yacht tender by **ALUNAUTIC.NL**



Pick your tender

